

GENERAL DESCRIPTION

The system can be used in various applications to move, lift and turn LED screens, scenery and projectable panels, such as like concerts and other events in general. The elements can be linear or curved. The system consists of a 52 stacking truss provided with a double track and/or a foldable dolly. It features a motor, a slave and a rotation trolley. It could be made in dark grey to absorb light, but other colors are available on request.

MAIN CHARACTERISTICS

DST52 has a trapezoidal section and it's stackable. The product's unique stacking design provides a space saving solution, while the fork connection system ensures maximum efficiency. May be brought on the stage with their dolly, which folds upward without the need of being stored when the truss works. Use of a few accessories that can be set up also on curved tracks. Easily assembled with the trolley which can be mounted even before rigging activities. All trolleys can run on straight and curved tracks. It comes equipped with a removable wheeled frame that facilitates easy connectability and maneuverability (only linear truss).

TECHNICAL CHARACTERISTICS

Description	Specification
External dimensions (height x width)	520 - 762 mm x 520 mm
Distance between axis	470 - 712 mm x 470 mm
Lengthways tubes	Extruded aluminium EN AW-6082 T6 – Ø50 x 4mm
Crossways tubes	Extruded aluminium EN AW-6082 T6 – Ø30 x 3mm
Connecting fork	Aluminium EN AW-6082 T6
Welding process	TIG (ISO 3834 / ISO 9606-02)

Section Area [mm ²]	Self-weight (approx.) [Kg/m]
2312	30
Moment of Inertia Y – axis [mm ⁴]	Moment of Inertia Z – axis [mm ⁴]
128.308.123	210.982.426

span [m]	UNIF. DISTRIBUTED LOAD			CENTRE POINT LOAD			THIRD POINT LOAD			QUARTER POINT LOAD			FIFTH POINT LOAD		
	q _{am} [kg/m]	q _{am} ·L [kg]	defl [mm]	F _{am.} [kg]	F _{am.} [kg]	defl [mm]	F _{am.} [kg]	2F _{am.} [kg]	defl [mm]	F _{am.} [kg]	3F _{am.} [kg]	defl [mm]	F _{am.} [kg]	4F _{am.} [kg]	defl [mm]
3	1760	5290	2	4410	4410	3	2640	5290	3	1760	5290	3	1320	5290	3
6	725	4350	14	2180	2180	11	1640	3270	14	1090	3260	13	907	3630	14
9	315	2830	31	1420	1420	25	1070	2140	32	708	2120	30	591	2370	32
12	171	2050	56	1030	1030	45	777	1550	57	513	1540	53	429	1720	56
15	105	1570	87	784	784	71	597	1190	90	392	1180	83	329	1310	88
18	68	1230	125	616	616	104	472	945	130	308	924	120	259	1040	127
21	47	980	170	490	490	144	380	759	177	245	735	163	207	827	173
24	33	781	222	391	391	191	306	613	233	195	586	214	165	662	226

Load table has been prepared in accordance with UNI ENV 1999-1-1 (Eurocode 9). When calculating the allowable loads shown in the table, it is assumed that the load is suspended in the middle part of the truss and the truss is supported from the top chord at each end. The values shown in the table are the allowable static loads that can be applied to the truss. This is the live load or the payload. The self-weight of the truss has been taken into account when calculating the values in the table. It should be noted that this are idealized loading conditions and the User shall re-analyse the truss for the loading condition which prevail for the application begin considered.

Please note that Technical Office of LITEC Italia S.r.l. could work and plan changes to the system standard on request of client.

STANDARD TRUSSES:

STK52R

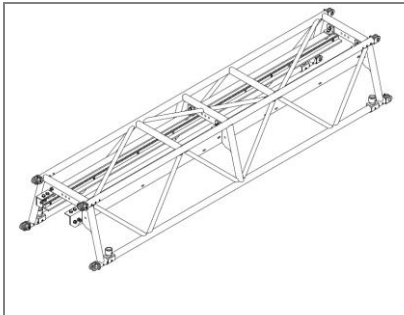

STK52RT

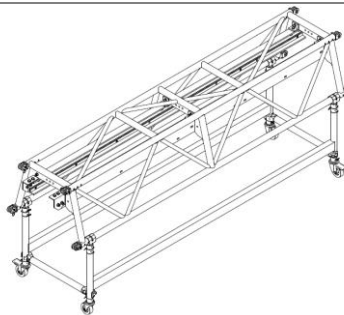

STK52RC

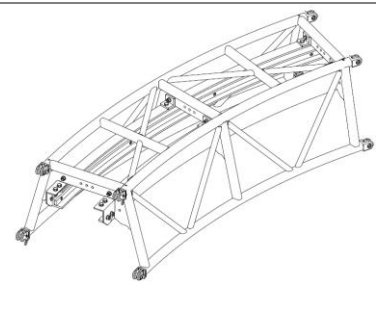

Litec Code	Length [cm]	Weight [kg]
STK52R100	100	38,0
STK52R150	150	51,0
STK52R300	300	88,1

Litec Code	Length [cm]	Weight [kg]
STK52RT100	100	54,4
STK52RT150	150	69,9
STK52RT300	300	116,6

Litec Code	Length min [cm]	Radius min [cm]
STK52RC	≤300	≥400

MODULES:

MOTORISED TROLLEY MODULE

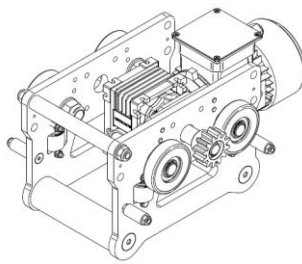

Litec Code: STK52MT	50 Hz
Self-weight	15,5 kg
Load Capacity	600 kg
Speed	10,17 m/min
Power	0,25 kW
Volt	400 V
Ampere	0,91 A

Litec Code: STK52MT3	50 Hz
Self-weight	15,5 kg
Load Capacity	600 kg
Speed	20,42 m/min
Power	0,37 kW
Volt	400 V
Ampere	1,05 A

ROTATION MODULE 360°

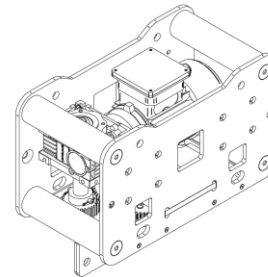

Litec Code: STK52MR3	50 Hz
Self-weight	20 kg
Load Capacity(*)	900 kg
Speed	5,65 rpm
Power	0,25 kW
Volt	400 V
Ampere	0,91 A

(*) see tables in the next pages

SLAVE TROLLEY

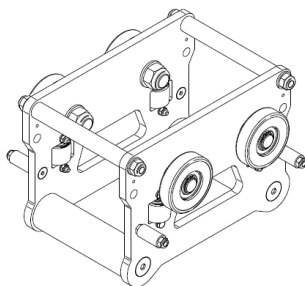

Code: STK52MS	
Self-Weight	7 kg
Load Capacity	600 kg

CABLE CARRIAGE

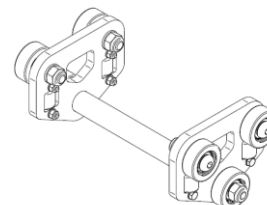

Code: STK52MC	
Load Capacity	1,3 kg
Load Capacity	100 kg

ACCESSORIES:

COUPLING TROLLEY & ROTATION MODULE

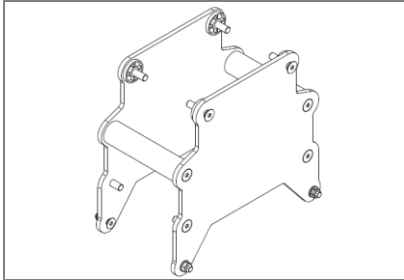

Litec Code	STK52MURT
DESCRIPTION	COUPLING FOR STK52MT, STK52MR AND ELETRONIC ELEMENTS
WEIGHT	8,6 kg

COUPLING TROLLEY & HOIST MODULE

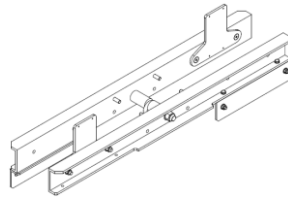

Litec Code	STK52MTH140
DESCRIPTION	COUPLING FOR STK52MT, HOIST AND ELETRONIC ELEMENTS
WEIGHT	24.3 kg
OTHER	IT CAN BE USED FOR HOIST LOADS

COUPLING TROLLEY & SLAVE MODULE

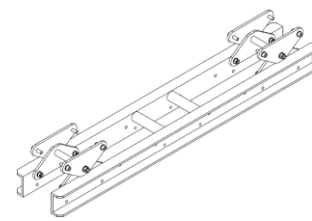

Litec Code	STK52MST175
DESCRIPTION	COUPLING FOR STK52MT AND STK52MS. IT IS USED TO HAVE A LOAD OF 1200kg.
WEIGHT	32,5 kg
OTHER	IT MUST USE STK52MAR ALSO, FOR ROTATION

ROTATION ADAPTER TO COUPLING TROLLEY & SLAVE MODULE

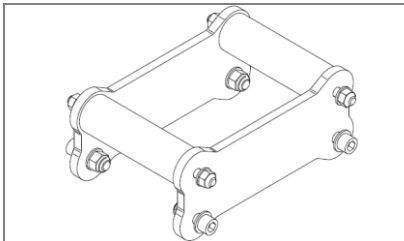

Litec Code	STK52MAR
DESCRIPTION	ROTATION ADAPTER TO COUPLING FOR TROLLEY & SLAVE MODULE
	STK52MST175
WEIGHT	3,7 kg

KIT FOR KINESYS ELEVATION

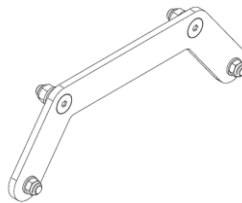

Litec Code	STK52MUE
DESCRIPTION	KIT FOR ELETRONIC ELEMENTS (ROTATION AND TRASLATION)
WEIGHT	0,9 kg

KIT FOR KINESYS CONTROL TROLLEY

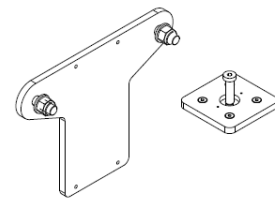

Litec Code	STK52MUK
DESCRIPTION	KIT FOR ELETRONIC ELEMENTS
WEIGHT	1,6 kg

KIT FOR KINESYS CONTROL TROLLEY ENCODER

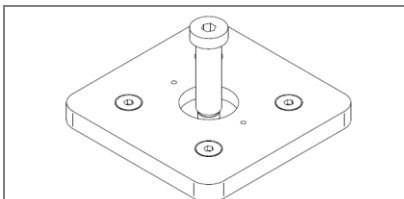

Litec Code	STK52MKE
DESCRIPTION	KIT FOR ELETRONIC'S ELEMENTS (ROTATION AND TRASLATION)
WEIGHT	0,3 kg

END STOP MODULE

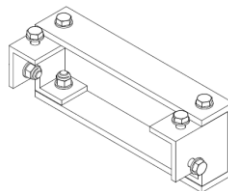

Litec Code	STK52MES
DESCRIPTION	END STOP MODULE FOR RAIL
WEIGHT	3,2 kg



EXE TECHNOLOGY
 Via Martin Luther King, 70
 Casale sul Sile (TV) - 31032 Italy

Tel. +39 0422 997300
 Fax. +39 0422 997399
 info@exetechnology.com

www.exetechnology.com



LT STK52MT	
50 Hz	
speed 10,17 m/min	
Ramp of acceleration or deceleration in second	Towing capacity [Kg]
1	1440**
2	1670**
3	1760**
4	1810**
5	1840**

LT STK52MT	
60 Hz	
speed 12,2 m/min	
Ramp of acceleration or deceleration in second	Towing capacity [Kg]
1	1150*
2	1360**
3	1450**
4	1500**
5	1530**

LT STK52MT3	
50 Hz	
speed 20,42 m/min	
Ramp of acceleration or deceleration in second	Towing capacity [Kg]
1	820*
2	1050*
3	1150*
4	1220*
5	1260*

LT STK52MT3	
60 Hz	
speed 24,41 m/min	
Ramp of acceleration or deceleration in second	Towing capacity [Kg]
1	630
2	840*
3	940*
4	990*
5	1030*

* to combine with a slave trolley (LT STK52MS)



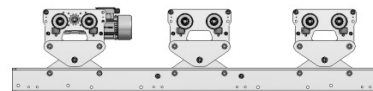

** to combine with two slave trolley (LT STK52MS)



The load capacity of a single trolley (motorized or slave) is 630 kg

<u>Speed</u> <u>[m/min]</u>		<u>High of Led screen [m]</u>																	
		0,5	1	1,5	2	2,5	3	3,5	4	4,5	5	5,5	6	6,5	7	7,5	8	8,5	9
<u>Max weight allowed [kg]</u>	50	35	35	35	35	35	35	35	35	35	35	35	35	35	35	35	35	35	35
	100	35	35	35	35	35	35	35	35	35	35	35	35	35	35	35	35	35	35
	150	30	35	35	35	35	35	35	35	35	35	35	35	35	35	35	35	35	35
	200	25	35	35	35	35	35	35	35	35	35	35	35	35	35	35	35	35	35
	250	23	32	35	35	35	35	35	35	35	35	35	35	35	35	34	32	31	31
	300	21	30	35	35	35	35	35	35	35	34	33	31	30	28	28	27	27	25
	350	19	27	34	35	33	33	32	32	31	30	27	26	26	25	23	23	22	22
	400	18	25	31	31	31	30	30	29	27	25	24	23	22	22	20	20	19	19
	450	17	24	30	29	28	28	27	25	24	23	22	20	19	19	18	18	18	16
	500	16	23	28	27	27	27	25	23	22	21	19	18	18	17	17	15	15	15
	550	15	22	27	26	25	24	22	21	20	18	17	16	16	14	14	14	13	13
	600	15	21	25	24	24	22	20	19	18	16	15	15	14	14	14	12	12	12
	650	14	20	24	23	22	20	19	17	16	16	15	13	13	13	12	12	12	10
	700	13	19	23	22	21	18	17	16	15	14	13	13	13	11	11	11	10	10
	750	13	18	22	22	19	18	16	15	14	14	12	12	11	11	11	9	9	9
	800	12	18	21	20	18	16	15	14	13	12	12	11	11	11	9	9	9	9
850	12	17	20	19	17	16	14	13	13	12	10	10	10	9	9	9	9	7	
900	12	17	20	18	16	14	13	12	11	11	10	10	9	9	9	9	7	7	

-  Up to now we don't have a trolley that can go with this speed
-  You can use only the trolley STK52MT3
-  You can use both our trolley (STK52MT & STK52MT3)



LT STK52MR - maximum screen inclination



		High of Led screen [m]																		
		0,5	1	1,5	2	2,5	3	3,5	4	4,5	5	5,5	6	6,5	7	7,5	8	8,5	9	
Max weight allowed [kg]	50	15	15	15	15	15	15	15	15	15	15	15	15	15	15	15	15	15	15	
	100	15	15	15	15	15	15	15	15	15	15	15	15	15	15	15	15	15	15	
	150	15	15	15	15	15	15	15	15	15	15	15	15	15	15	15	15	15	15	
	200	15	15	15	15	15	15	15	15	15	15	15	15	15	15	15	15	14	13	12
	250	15	15	15	15	15	15	15	15	15	15	15	15	15	14	13	12	11	10	10
	300	15	15	15	15	15	15	15	15	15	15	15	14	12	11	10	10	9	9	8
	350	15	15	15	15	15	15	15	15	15	14	13	11	10	10	9	8	8	7	7
	400	15	15	15	15	15	15	15	15	14	12	11	10	9	8	8	7	7	6	6
	450	15	15	15	15	15	15	15	14	12	11	10	9	8	7	7	6	6	6	5
	500	15	15	15	15	15	15	15	13	11	10	9	8	7	7	6	6	5	5	5
	550	15	15	15	15	15	15	14	11	10	9	8	7	6	6	5	5	5	4	4
	600	15	15	15	15	15	15	12	10	9	8	7	6	6	5	5	5	4	4	4
	650	15	15	15	15	14	11	10	8	7	7	6	5	5	5	4	4	4	4	3
	700	15	15	15	15	13	10	9	8	7	6	5	5	5	4	4	4	4	3	3
	750	15	15	15	15	12	10	8	7	6	6	5	5	4	4	4	4	3	3	3
	800	15	15	15	14	11	9	8	7	6	5	5	4	4	4	3	3	3	3	3
	850	15	15	15	13	10	9	7	6	6	5	4	4	4	3	3	3	3	3	2
900	15	15	15	12	10	8	7	6	5	5	4	4	3	3	3	3	2	2	2	

Rev. 0001	Date of issue 12/10/2016	Description First edition	Sign SA
--------------	-----------------------------	------------------------------	------------

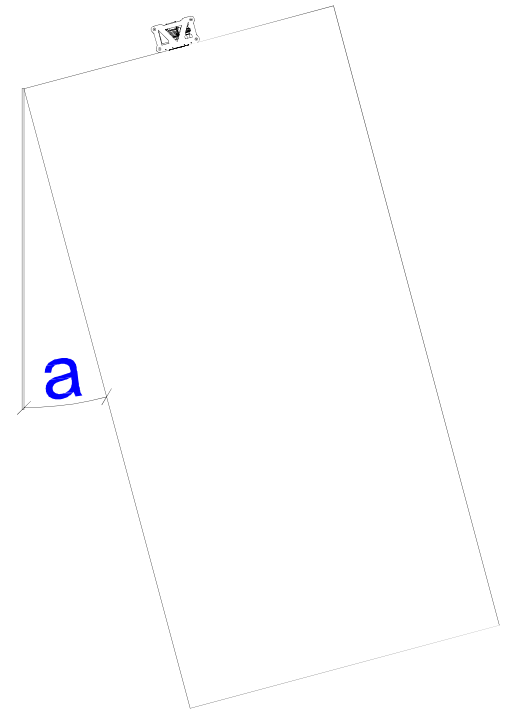
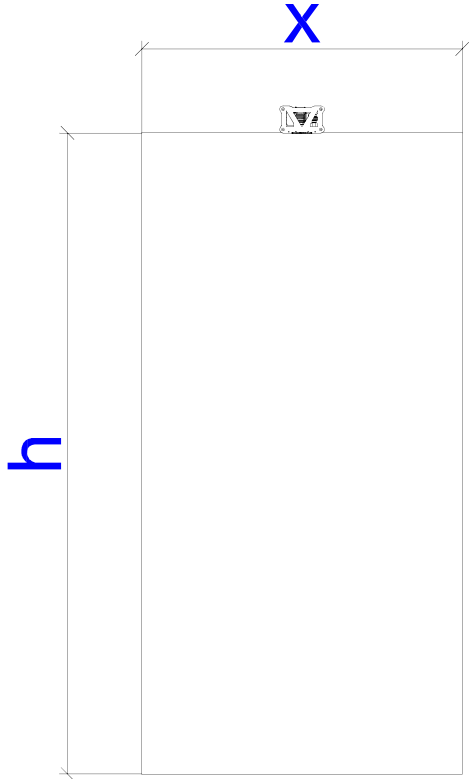

General layout: not suitable for construction Disegno di massima: non vincolante ai fini esecutivi		Weight [kg]	Scale 1:1	
	Created by Santello A.	Checked by LT	Approved by LT	
<small>LITEC s.p.a. - Via S. Felice 10 - 10125 Casale Monferrato (TO) - Italy Tel. +39 0422 957300 - Fax +39 0422 997399 http://www.litec.com - e-mail: info@litec.com</small>	Title/Supplementary title -		Date of issue 12/10/2016	
<small>This drawing is copyright and the property of LITEC s.p.a. and no part of it can be used or reproduced for any purpose without the written consent of the company.</small>	Code name/File name 02_inclination max	Document status Released	Paper size A3	Sheet 1/1

IF IN DOUBT ASK



LT STK52MR - maximum bottom horizontal force



Force [Kg]		High of Led screen [m]																	
		0,5	1	1,5	2	2,5	3	3,5	4	4,5	5	5,5	6	6,5	7	7,5	8	8,5	9
Max weight allowed [kg]	50	300	300	300	300	300	300	300	300	300	300	300	300	300	300	300	300	137	95
	100	300	300	300	300	300	300	300	300	190	131	104	88	77	68	62	57	52	49
	150	300	300	300	300	300	286	173	132	108	93	82	73	66	61	56	52	49	46
	200	300	300	300	300	262	175	137	113	97	86	77	69	63	58	54	51	47	45
	250	300	300	300	300	204	155	126	107	93	83	75	68	62	58	54	50	47	44
	300	300	300	300	263	186	146	121	104	91	81	74	67	62	57	53	50	47	44
	350	300	300	300	239	176	141	119	102	90	81	73	67	61	57	53	50	47	44
	400	300	300	300	227	171	139	117	101	89	80	73	66	61	57	53	49	46	44
	450	300	300	300	219	168	137	116	101	89	80	72	66	61	57	53	49	46	44
	500	300	300	300	214	166	136	115	100	89	80	72	66	61	56	53	49	46	44
	550	300	300	299	211	164	135	115	100	88	79	72	66	61	56	53	49	46	44
	600	300	300	292	208	163	134	114	99	88	79	72	66	61	56	53	49	46	44
	650	300	300	287	206	162	134	114	99	88	79	72	66	61	56	52	49	46	44
	700	300	300	283	205	161	133	114	99	88	79	72	66	61	56	52	49	46	44
	750	300	300	280	204	161	133	113	99	88	79	72	66	61	56	52	49	46	44
	800	300	300	277	203	160	133	113	99	88	79	72	66	61	56	52	49	46	44
850	300	300	276	202	160	132	113	99	88	79	72	66	61	56	52	49	46	44	
900	300	300	274	201	160	132	113	99	88	79	72	66	61	56	52	49	46	44	

Rev. 0001	Date of issue 12/10/2016	Description First edition	Sign SA
--------------	-----------------------------	------------------------------	------------

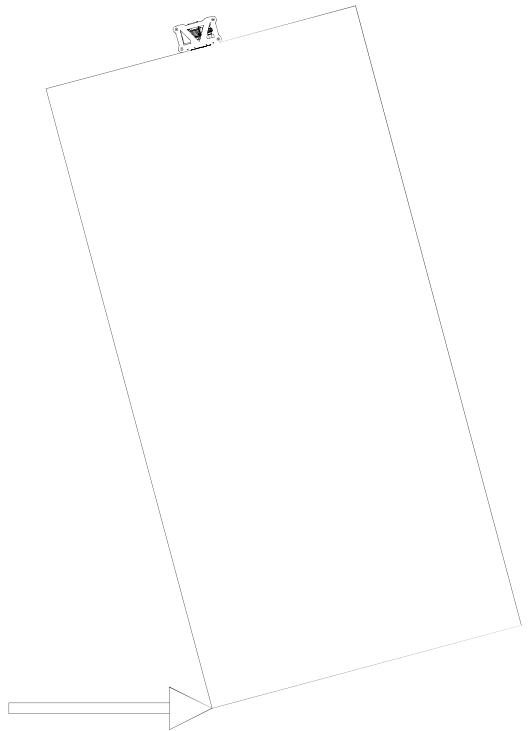
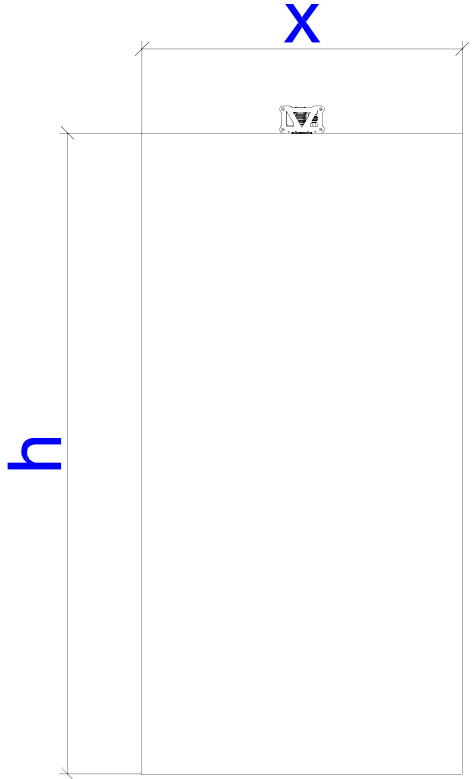

General layout: not suitable for construction Disegno di massima: non vincolante ai fini esecutivi		Weight [kg]	Scale 1X	
	Created by Santello A.	Checked by LT	Approved by LT	
Title/Supplementary title -		Date of issue 12/10/2016		
Code name/File name 02_force max		Document status Released	Paper size A3	Sheet 1/1

IF IN DOUBT ASK